

Rastele de transport – Deltarack Economy

Rastelele din lemn din gama Economy sunt executate din panel stratificat (13 straturi) din mesteacan cu grosimea de 18 mm. Se recomanda ca aceste rastele sa nu fie expuse la umezeala si sa nu fie depozitate afara.

Deoarece rastelele din clasa SG sunt inguste, avand doar 60 cm latime, sunt construite cu posibilitatea de a fi imbinate unul cate unul pe laterala lunga, crescand in acest fel stabilitatea lor in timpul transportului. De asemenea, acest fapt permite o mai buna asigurare cu chinga de ancorare de catre transportator.



Clasa SG

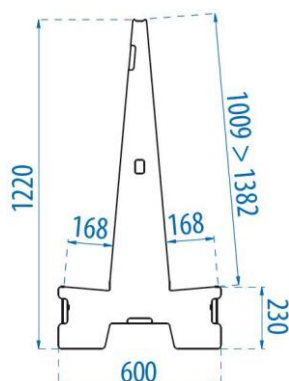

1009 mm – inaltimea utila de asezare pe o parte

1382 mm – înălțimea la care cele două laterale se întâlnesc la varf

SG.120/2 - SG.120/3

Max. 500 kg

Weighth 12 kg - Weighth 15 kg

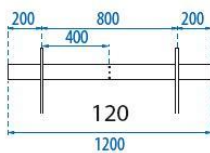
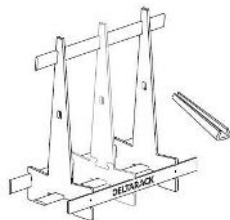

-lungimea utila de asezare: 120 cm

SG.180/4

Max. load 750 kg

Weighth 20 kg

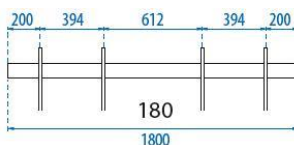
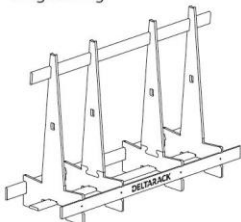

-lungimea utila de asezare: 180 cm

SG.240/4

Max. 1000 kg

Weighth 23 kg

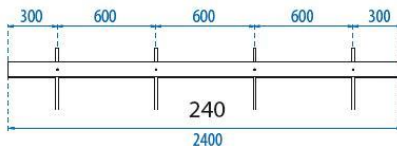
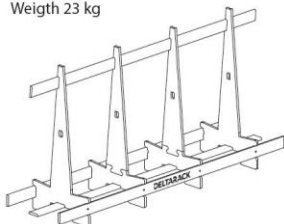

-lungimea utila de asezare: 240 cm

SG.300/6

Max. 1250 kg

Weighth 32 kg

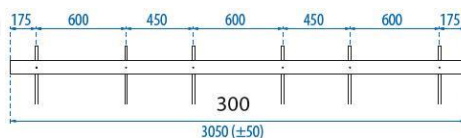
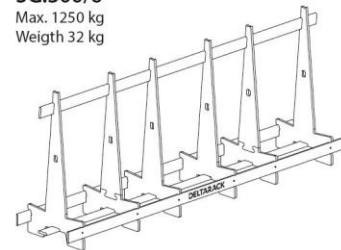

-lungimea utila de asezare: 300 cm

Clasa SR

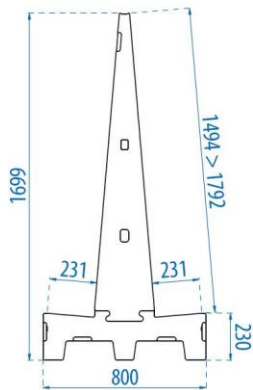

1494 mm – înălțimea utila de asezare pe o parte
1792 mm – înălțimea la care cele doua laterale se intalnesc la varf

SR.120/2 - SR.120/3
Max. 500 kg
Weigth 16 kg - Weigth 20 kg

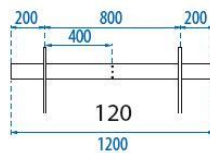
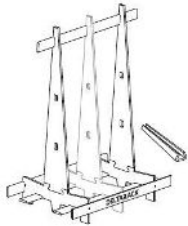

-lungimea utila de asezare: 120 cm

SR.180/4
Max. 750 kg
Weigth 28 kg

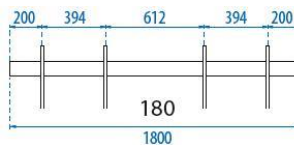
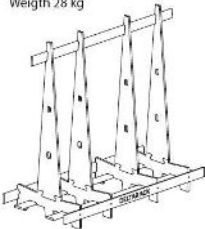

-lungimea utila de asezare: 180 cm

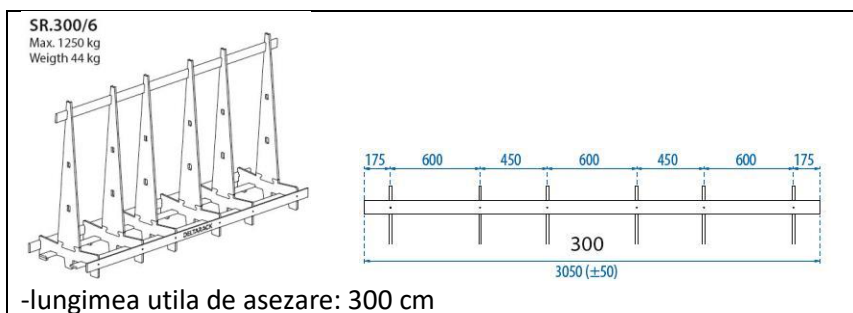
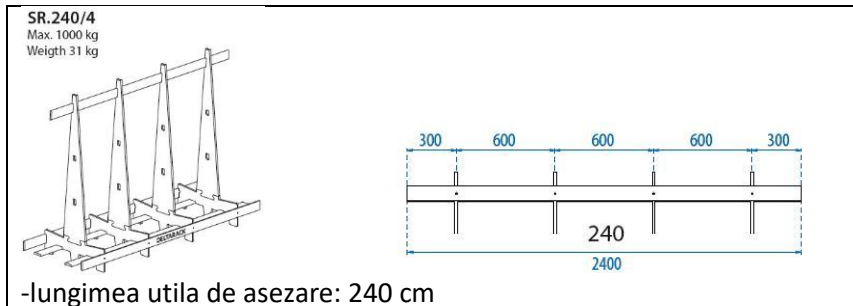

Optional pentru toate tipurile de rastele:

Protectie baza

